

Data sheet

Hydraulic / Pneumatic - Ball valves, Valves - Ball valves with Thread

Two Piece Ball Valve

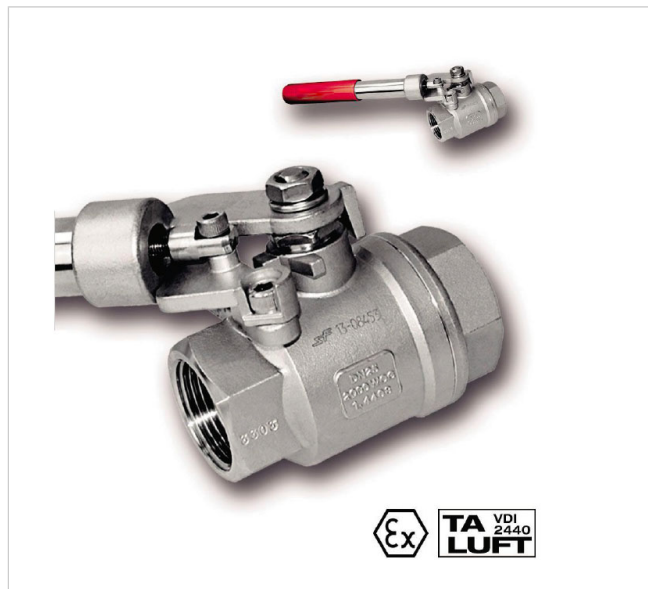

open Passage, with parallel BSP thread to EN ISO 228-1, with spring return in the hand lever

Connection 1 G 1/4"
Material 1.4408

Technical information

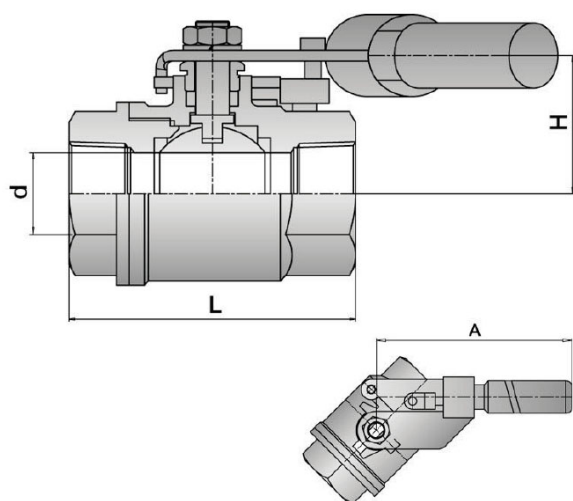

Connection 1: G 1/4"
Material: 1.4408
PN: 130
DN: 8
G: G 1/4"
d: 9,6
L: 57,0
H: 29,5
A: 184
Weight: 560 g

Details

Housing and ball made of AISI 316. Sealing material PTFE. Ex according to Directive 2014/34/EU. We reserve the right to alter dimensions. Please note the pressure-temperature diagram.