

Selection diagram

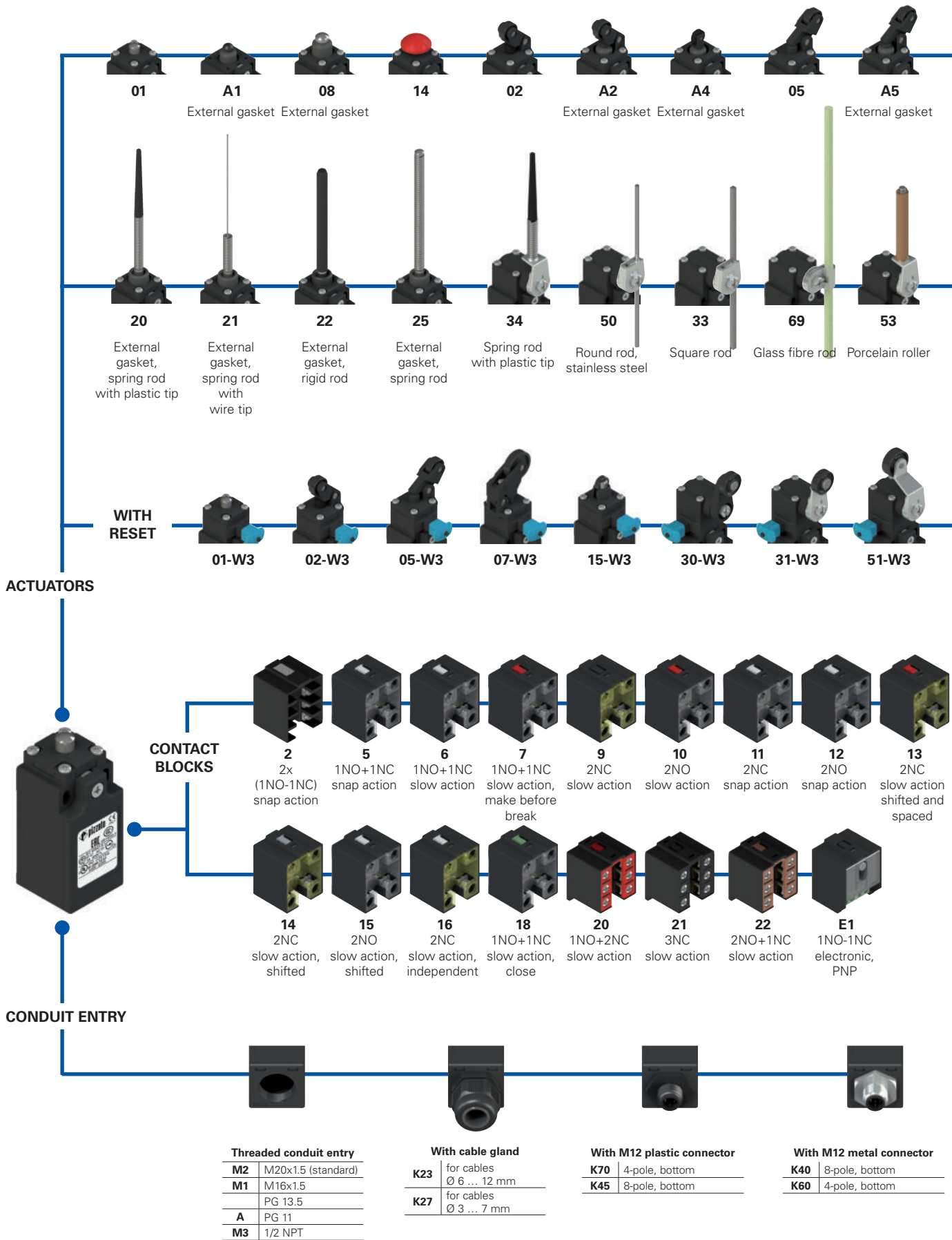
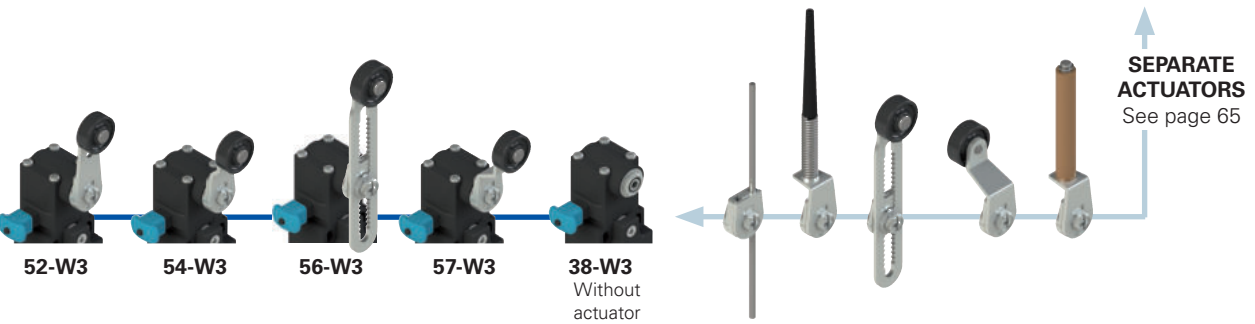
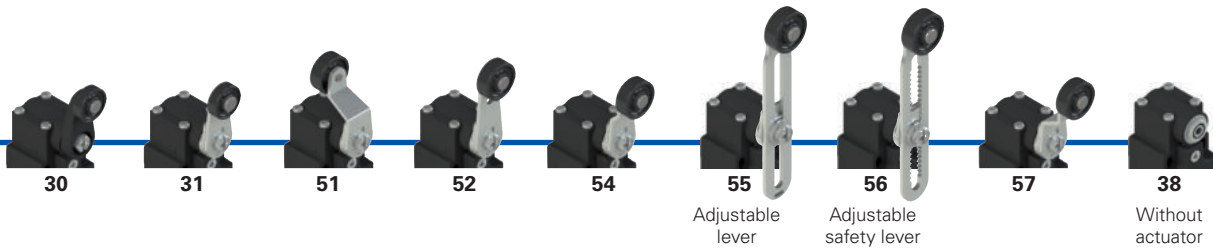
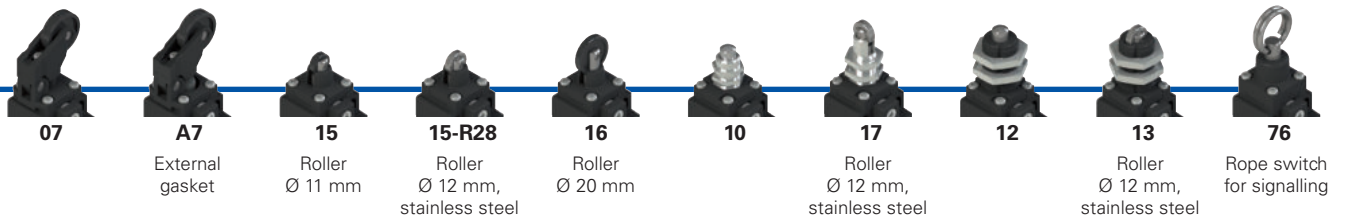

● Product options
 → Sold separately as accessory

Code structure

Attention! The feasibility of a code number does not mean the effective availability of a product. Please contact our sales office.

article options options
FR 502-W3XGM2K70R23T6

Housing	
FR	technopolymer, one conduit entry

Contact block	
5	1NO+1NC, snap action
6	1NO+1NC, slow action
7	1NO+1NC, slow action, make before break
...

Actuators	
01	short plunger
02	roller lever
05	angled lever with roller
...

Reset	
	without reset (standard)
W3	simultaneous reset
W4	simultaneous reset, increased force

External metallic parts	
	zinc-plated steel (standard)
X	stainless steel

Ambient temperature	
	-25°C ... +80°C (standard)
T6	-40°C ... +80°C

Pre-installed cable glands or connectors	
	no cable gland or connector (standard)
K23	cable gland for cables Ø 6 ... 12 mm
K70	M12 plastic connector, 4-pole

For the complete list of possible combinations please contact our technical department.

Threaded conduit entry	
M2	M20x1.5 (standard)
M1	M16x1.5
	PG 13.5
A	PG 11
M3	1/2 NPT

Rollers	
	standard roller
R28	stainless steel Ø 12 mm (for actuators A4, 15)
R23	stainless steel Ø 14 mm (for actuators A2, 02, A5, 05, 30, 31, 51, 52, 54, 55, 56, 57)
R24	stainless steel Ø 20 mm (for actuators 30, 31, 51, 52, 54, 55, 56, 57)
R25	technopolymer, Ø 35 mm (for actuators 30, 31, 51, 52, 54, 55, 56, 57)
R5	rubber, Ø 40 mm (for actuators 30, 31, 51, 52, 54, 55, 56, 57)
R26	rubber, Ø 50 mm (for actuators 51, 52, 54, 55, 56, 57)
R27	rubber, protruding, Ø 50 mm (for actuators 55, 56)

Contact type	
	silver contacts (standard)
G	silver contacts, 1 µm gold coating
G1	silver contacts, 2.5 µm gold coating (not for contact block 2, 20, 21, 22)

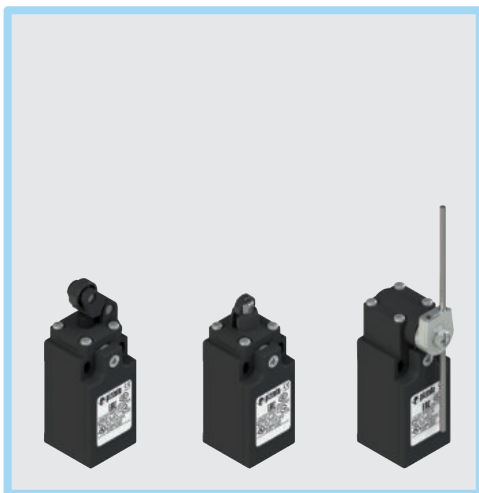

Main features

- Technopolymer housing, one conduit entry
- Protection degree IP67
- 17 contact blocks available
- 48 actuators available
- Versions with external parts in stainless steel
- Versions with M12 connector
- Versions with gold-plated silver contacts

Quality marks:



IMQ approval:	EG610
UL approval:	E131787
CCC approval:	2007010305230013
EAC approval:	RU C-IT.YT03.B.00035/19

Technical data

Housing

Housing made of glass fibre reinforced technopolymer, self-extinguishing, shock-proof and with double insulation: 

One threaded conduit entry:	M20x1.5 (standard)
Protection degree acc. to EN 60529:	IP67 with cable gland of equal or higher protection degree

General data

Ambient temperature:	-25°C ... +80°C (standard) -40°C ... +80°C (T6 option)
Max. actuation frequency:	3600 operating cycles/hour
Mechanical endurance:	20 million operating cycles
Mounting position:	any
Safety parameter B _{10D} :	40,000,000 for NC contacts
Mechanical interlock, not coded:	type 1 acc. to EN ISO 14119
Tightening torques for installation:	see page 227
Wire cross-sections and wire stripping lengths:	see page 243

In compliance with standards:

IEC 60947-5-1, EN 60947-5-1, EN 60947-1, EN 50047, IEC 60204-1, EN 60204-1, EN ISO 14119, EN ISO 12100, IEC 60529, EN 60529, EN 50581, UL 508, CSA 22.2 No. 14

Approvals:

IEC 60947-5-1, UL 508, CSA 22.2 No. 14, GB/T14048.5-2017.

Compliance with the requirements of:

Low Voltage Directive 2014/35/EU, EMC Directive 2014/30/EU, RoHS Directive 2011/65/EU.

Positive contact opening in conformity with standards:

IEC 60947-5-1, EN 60947-5-1.

Installation for safety applications:

Use only switches marked with the symbol  next to the product code. Always connect the safety circuit to the **NC contacts** (normally closed contacts: 11-12, 21-22 or 31-32) as required by **EN ISO 14119, paragraph 5.4** for specific interlock applications and **EN ISO 13849-2 tables D3** (well-tried components) and **D.8** (fault exclusions) for safety applications in general. Actuate the switch **at least up to the positive opening travel** shown in the travel diagrams on page 228. Actuate the switch **at least with the positive opening force**, reported in brackets below each article, next to the actuating force value.

⚠ If not expressly indicated in this chapter, for correct installation and utilization of all articles see the instructions given on pages 223 to 236.

	Electrical data	Utilization category
without connector	Thermal current (I _{th}):	10 A
	Rated insulation voltage (U):	500 Vac 600 Vdc 400 Vac 500 Vdc (contact blocks 2, 11, 12, 20, 21, 22)
	Rated impulse withstand voltage (U _{imp}):	6 kV 4 kV (contact blocks 20, 21, 22)
	Conditional short circuit current: Protection against short circuits: Pollution degree:	1000 A acc. to EN 60947-5-1 type aM fuse 10 A 500 V 3
with M12 connector, 4-pole	Thermal current (I _{th}):	4 A
	Rated insulation voltage (U):	250 Vac 300 Vdc
	Protection against short circuits: Pollution degree:	type gG fuse 4 A 500 V 3
		Alternating current: AC15 (50÷60 Hz) Ue (V) 24 120 250 Ie (A) 4 4 4 Direct current: DC13 Ue (V) 24 125 250 Ie (A) 3 0.55 0.3
with M12 connector, 8-pole	Thermal current (I _{th}):	2 A
	Rated insulation voltage (U):	30 Vac 36 Vdc
	Protection against short circuits: Pollution degree:	type gG fuse 2 A 500 V 3
		Alternating current: AC15 (50÷60 Hz) Ue (V) 24 Ie (A) 2 Direct current: DC13 Ue (V) 24 Ie (A) 2



Features approved by IMQ

Rated insulation voltage (U_i): 500 Vac
 400 Vac (for contact blocks 2, 11, 12, 20, 21, 22, 33, 34)

Conventional free air thermal current (I_{th}): 10 A

Protection against short circuits: type aM fuse 10 A 500 V

Rated impulse withstand voltage (U_{imp}): 6 kV
 4 kV (for contact blocks 20, 21, 22, 33, 34)

Protection degree of the housing: IP67

MV terminals (screw terminals)

Pollution degree: 3

Utilization category: AC15

Operating voltage (U_e): 400 Vac (50 Hz)

Operating current (I_e): 3 A

Forms of the contact element: Za, Zb, Za+Za, Y+Y, X+X, Y+Y+X, Y+Y+Y, Y+X+X

Positive opening of contacts on contact blocks 5, 6, 7, 9, 11, 13, 14, 16, 18, 20, 21, 22, 33, 34

In compliance with standards: EN 60947-1, EN 60947-5-1, fundamental requirements of the Low Voltage Directive 2014/35/EU.

Please contact our technical department for the list of approved products.

Features approved by UL

Electrical Ratings: Q300 pilot duty (69 VA, 125-250 V dc)
 A600 pilot duty (720 VA, 120-600 V ac)

Environmental Ratings: Types 1, 4X, 12, 13

For all contact blocks except 2 and 3 use 60 or 75°C copper (Cu) conductors, rigid or flexible, wire size 12, 14 AWG. Tightening torque for terminal screws of 7.1 lb in (0.8 Nm).

For contact blocks 2 and 3 use 60 or 75°C copper (Cu) conductors, rigid or flexible, wire size 14 AWG. Tightening torque for terminal screws of 12 lb in (1.4 Nm).

The hub is to be connected to the conduit before the hub is connected to the enclosure

Please contact our technical department for the list of approved products.

Wiring diagram for M12 connectors

Contact block 2 2x(1NO-1NC)	Contact block 5 1NO+1NC	Contact block 6 1NO+1NC	Contact block 7 1NO+1NC	Contact block 9 2NC	Contact block 10 2NO	Contact block 11 2NC	Contact block 12 2NO	Contact block 13 2NC
M12 connector, 8-pole	M12 connector, 4-pole	M12 connector, 4-pole	M12 connector, 4-pole	M12 connector, 4-pole	M12 connector, 4-pole	M12 connector, 4-pole	M12 connector, 4-pole	M12 connector, 4-pole

Contacts	Pin no.	Contacts	Pin no.	Contacts	Pin no.	Contacts	Pin no.	Contacts	Pin no.	Contacts	Pin no.	Contacts	Pin no.
NO	3-4	NC	1-2	NC	1-2	NC	1-2	NC	1-2	NO	1-2	NC (1°)	1-2
NC	5-6	NO	3-4	NO	3-4	NO	3-4	NC	3-4	NO	3-4	NO	3-4
NC	7-8												
NO	1-2												

Contact block 14 2NC	Contact block 15 2NO	Contact block 16 2NC	Contact block 18 1NO+1NC	Contact block 20 1NO+2NC	Contact block 21 3NC	Contact block 22 2NO+1NC	Contact block 33 1NO+1NC	Contact block 34 2NC
M12 connector, 4-pole	M12 connector, 4-pole	M12 connector, 4-pole	M12 connector, 4-pole	M12 connector, 8-pole	M12 connector, 8-pole	M12 connector, 8-pole	M12 connector, 4-pole	M12 connector, 4-pole

Contacts	Pin no.	Contacts	Pin no.	Contacts	Pin no.	Contacts	Pin no.	Contacts	Pin no.	Contacts	Pin no.	Contacts	Pin no.
NC (1°)	1-2	NO (1°)	1-2	NC, lever to the right	1-2	NC	1-2	NC	3-4	NC	3-4	NC	3-4
NC (2°)	3-4	NO (2°)	3-4	NC, lever to the left	3-4	NO	3-4	NC	5-6	NO	5-6	NO	3-4

Contact block E1 PNP
M12 connector, 4-pole

Contacts	Pin no.
+	1
-	3
NC	2
NO	4

FR series position switches

Contact type:

- R** = snap action
- L** = slow action
- LO** = slow action make before break
- LS** = slow action shifted
- LV** = slow action shifted and spaced
- LI** = slow action independent
- LA** = slow action close
- ⚡** = electronic PNP

Contact block

			External gasket		With stainless steel roller on request		External gasket		With stainless steel roller on request
2	R	FR 201-M2	2x(1NO-1NC)	/	FR 202-M2	2x(1NO-1NC)	FR 2A2-M2	2x(1NO-1NC)	
5	R	FR 501-M2	⊕ 1NO+1NC	FR 5A1-M2	⊕ 1NO+1NC	FR 502-M2	⊕ 1NO+1NC	FR 5A2-M2	⊕ 1NO+1NC
6	L	FR 601-M2	⊕ 1NO+1NC	FR 6A1-M2	⊕ 1NO+1NC	FR 602-M2	⊕ 1NO+1NC	FR 6A2-M2	⊕ 1NO+1NC
7	LO	FR 701-M2	⊕ 1NO+1NC	FR 7A1-M2	⊕ 1NO+1NC	FR 702-M2	⊕ 1NO+1NC	FR 7A2-M2	⊕ 1NO+1NC
9	L	FR 901-M2	⊕ 2NC	FR 9A1-M2	⊕ 2NC	FR 902-M2	⊕ 2NC	FR 9A2-M2	⊕ 2NC
10	L	FR 1001-M2	2NO	FR 10A1-M2	2NO	FR 1002-M2	2NO	FR 10A2-M2	2NO
11	R	FR 1101-M2	⊕ 2NC	FR 11A1-M2	⊕ 2NC	FR 1102-M2	⊕ 2NC	FR 11A2-M2	⊕ 2NC
12	R	FR 1201-M2	2NO	FR 12A1-M2	2NO	FR 1202-M2	2NO	FR 12A2-M2	2NO
13	LV	FR 1301-M2	⊕ 2NC	FR 13A1-M2	⊕ 2NC	FR 1302-M2	⊕ 2NC	FR 13A2-M2	⊕ 2NC
14	LS	FR 1401-M2	⊕ 2NC	FR 14A1-M2	⊕ 2NC	FR 1402-M2	⊕ 2NC	FR 14A2-M2	⊕ 2NC
15	LS	FR 1501-M2	2NO	FR 15A1-M2	2NO	FR 1502-M2	2NO	FR 15A2-M2	2NO
18	LA	FR 1801-M2	⊕ 1NO+1NC	FR 18A1-M2	⊕ 1NO+1NC	FR 1802-M2	⊕ 1NO+1NC	FR 18A2-M2	⊕ 1NO+1NC
20	L	FR 2001-M2	⊕ 1NO+2NC	FR 20A1-M2	⊕ 1NO+2NC	FR 2002-M2	⊕ 1NO+2NC	FR 20A2-M2	⊕ 1NO+2NC
21	L	FR 2101-M2	⊕ 3NC	FR 21A1-M2	⊕ 3NC	FR 2102-M2	⊕ 3NC	FR 21A2-M2	⊕ 3NC
22	L	FR 2201-M2	⊕ 2NO+1NC	FR 22A1-M2	⊕ 2NO+1NC	FR 2202-M2	⊕ 2NO+1NC	FR 22A2-M2	⊕ 2NO+1NC
E1	⚡	FR E101-M2	1NO-1NC	FR E1A1-M2	1NO-1NC	FR E102-M2	1NO-1NC	FR E1A2-M2	1NO-1NC
Max. speed		page 227 - type 4		page 227 - type 4		page 227 - type 3		page 227 - type 3	
Actuating force		8 N (25 N ⊕)		6 N (25 N ⊕)		6 N (25 N ⊕)		4.3 N (25 N ⊕)	
Travel diagrams		page 228 - group 1		page 228 - group 1		page 228 - group 2		page 228 - group 2	

Contact type:

- R** = snap action
- L** = slow action
- LO** = slow action make before break
- LS** = slow action shifted
- LV** = slow action shifted and spaced
- LI** = slow action independent
- LA** = slow action close
- ⚡** = electronic PNP

Contact block

		External gasket		With stainless steel roller on request		External gasket		With stainless steel roller on request	
2	R	FR 2A4-M2	2x(1NO-1NC)	FR 205-M2	2x(1NO-1NC)	FR 2A5-M2	2x(1NO-1NC)	FR 207-M2	2x(1NO-1NC)
5	R	FR 5A4-M2	⊕ 1NO+1NC	FR 505-M2	⊕ 1NO+1NC	FR 5A5-M2	⊕ 1NO+1NC	FR 507-M2	⊕ 1NO+1NC
6	L	FR 6A4-M2	⊕ 1NO+1NC	FR 605-M2	⊕ 1NO+1NC	FR 6A5-M2	⊕ 1NO+1NC	FR 607-M2	⊕ 1NO+1NC
7	LO	FR 7A4-M2	⊕ 1NO+1NC	FR 705-M2	⊕ 1NO+1NC	FR 7A5-M2	⊕ 1NO+1NC	FR 707-M2	⊕ 1NO+1NC
9	L	FR 9A4-M2	⊕ 2NC	FR 905-M2	⊕ 2NC	FR 9A5-M2	⊕ 2NC	FR 907-M2	⊕ 2NC
10	L	FR 10A4-M2	2NO	FR 1005-M2	2NO	FR 10A5-M2	2NO	FR 1007-M2	2NO
11	R	FR 11A4-M2	⊕ 2NC	FR 1105-M2	⊕ 2NC	FR 11A5-M2	⊕ 2NC	FR 1107-M2	⊕ 2NC
12	R	FR 12A4-M2	2NO	FR 1205-M2	2NO	FR 12A5-M2	2NO	FR 1207-M2	2NO
13	LV	FR 13A4-M2	⊕ 2NC	FR 1305-M2	⊕ 2NC	FR 13A5-M2	⊕ 2NC	FR 1307-M2	⊕ 2NC
14	LS	FR 14A4-M2	⊕ 2NC	FR 1405-M2	⊕ 2NC	FR 14A5-M2	⊕ 2NC	FR 1407-M2	⊕ 2NC
15	LS	FR 15A4-M2	2NO	FR 1505-M2	2NO	FR 15A5-M2	2NO	FR 1507-M2	2NO
18	LA	FR 18A4-M2	⊕ 1NO+1NC	FR 1805-M2	⊕ 1NO+1NC	FR 18A5-M2	⊕ 1NO+1NC	FR 1807-M2	⊕ 1NO+1NC
20	L	FR 20A4-M2	⊕ 1NO+2NC	FR 2005-M2	⊕ 1NO+2NC	FR 20A5-M2	⊕ 1NO+2NC	FR 2007-M2	⊕ 1NO+2NC
21	L	FR 21A4-M2	⊕ 3NC	FR 2105-M2	⊕ 3NC	FR 21A5-M2	⊕ 3NC	FR 2107-M2	⊕ 3NC
22	L	FR 22A4-M2	⊕ 2NO+1NC	FR 2205-M2	⊕ 2NO+1NC	FR 22A5-M2	⊕ 2NO+1NC	FR 2207-M2	⊕ 2NO+1NC
E1	⚡	FR E1A4-M2	1NO-1NC	FR E105-M2	1NO-1NC	FR E1A5-M2	1NO-1NC	FR E107-M2	1NO-1NC
Max. speed		page 227 - type 5		page 227 - type 3		page 227 - type 3		page 227 - type 3	
Actuating force		6 N (25 N ⊕)		6 N (25 N ⊕)		4.3 N (25 N ⊕)		4 N (25 N ⊕)	
Travel diagrams		page 228 - group 1		page 228 - group 2		page 228 - group 2		page 228 - group 3	

All values in the drawings are in mm

Accessories See page 207

→ The 2D and 3D files are available at www.pizzato.com



<p>Contact type:</p> <ul style="list-style-type: none"> R = snap action L = slow action LO = slow action make before break LS = slow action shifted LV = slow action shifted and spaced LI = slow action independent LA = slow action close A = electronic PNP 	<p>External gasket</p>	<p>External gasket</p>	<p>Secured only by means of threaded head in vertical position</p>					
Contact block								
2 R	FR 2A7-M2	2x(1NO-1NC)	FR 208-M2	2x(1NO-1NC)	FR 210-M2	2x(1NO-1NC)	FR 212-M2	2x(1NO-1NC)
5 R	FR 5A7-M2	⊕ 1NO+1NC	FR 508-M2	⊕ 1NO+1NC	FR 510-M2	⊕ 1NO+1NC	FR 512-M2	⊕ 1NO+1NC
6 L	FR 6A7-M2	⊕ 1NO+1NC	FR 608-M2	⊕ 1NO+1NC	FR 610-M2	⊕ 1NO+1NC	FR 612-M2	⊕ 1NO+1NC
7 LO	FR 7A7-M2	⊕ 1NO+1NC	FR 708-M2	⊕ 1NO+1NC	FR 710-M2	⊕ 1NO+1NC	FR 712-M2	⊕ 1NO+1NC
9 L	FR 9A7-M2	⊕ 2NC	FR 908-M2	⊕ 2NC	FR 910-M2	⊕ 2NC	FR 912-M2	⊕ 2NC
10 L	FR 10A7-M2	2NO	FR 1008-M2	2NO	FR 1010-M2	2NO	FR 1012-M2	2NO
11 R	FR 11A7-M2	⊕ 2NC	FR 1108-M2	⊕ 2NC	FR 1110-M2	⊕ 2NC	FR 1112-M2	⊕ 2NC
12 R	FR 12A7-M2	2NO	FR 1208-M2	2NO	FR 1210-M2	2NO	FR 1212-M2	2NO
13 LV	FR 13A7-M2	⊕ 2NC	FR 1308-M2	⊕ 2NC	FR 1310-M2	⊕ 2NC	FR 1312-M2	⊕ 2NC
14 LS	FR 14A7-M2	⊕ 2NC	FR 1408-M2	⊕ 2NC	FR 1410-M2	⊕ 2NC	FR 1412-M2	⊕ 2NC
15 LS	FR 15A7-M2	2NO	FR 1508-M2	2NO	FR 1510-M2	2NO	FR 1512-M2	2NO
18 LA	FR 18A7-M2	⊕ 1NO+1NC	FR 1808-M2	⊕ 1NO+1NC	FR 1810-M2	⊕ 1NO+1NC	FR 1812-M2	⊕ 1NO+1NC
20 L	FR 20A7-M2	⊕ 1NO+2NC	FR 2008-M2	⊕ 1NO+2NC	FR 2010-M2	⊕ 1NO+2NC	FR 2012-M2	⊕ 1NO+2NC
21 L	FR 21A7-M2	⊕ 3NC	FR 2108-M2	⊕ 3NC	FR 2110-M2	⊕ 3NC	FR 2112-M2	⊕ 3NC
22 L	FR 22A7-M2	⊕ 2NO+1NC	FR 2208-M2	⊕ 2NO+1NC	FR 2210-M2	⊕ 2NO+1NC	FR 2212-M2	⊕ 2NO+1NC
E1 A	FR E1A7-M2	1NO-1NC	FR E108-M2	1NO-1NC	FR E110-M2	1NO-1NC	FR E112-M2	1NO-1NC
Max. speed	page 227 - type 3		page 227 - type 4		page 227 - type 4		page 227 - type 4	
Actuating force	3 N (25 N ⊕)		8 N (25 N ⊕)		8 N (25 N ⊕)		8 N (25 N ⊕)	
Travel diagrams	page 228 - group 3		page 228 - group 1		page 228 - group 1		page 228 - group 1	

<p>Contact type:</p> <ul style="list-style-type: none"> R = snap action L = slow action LO = slow action make before break LS = slow action shifted LV = slow action shifted and spaced LI = slow action independent LA = slow action close A = electronic PNP 			<p>Roller, Ø 11 mm, technopolymer</p>	<p>Roller, Ø 12 mm, stainless steel</p>				
Contact block								
2 R	FR 213-M2	2x(1NO-1NC)	FR 214-M2	2x(1NO-1NC)	FR 215-M2	2x(1NO-1NC)	FR 215-M2R28	2x(1NO-1NC)
5 R	FR 513-M2	⊕ 1NO+1NC	FR 514-M2	⊕ 1NO+1NC	FR 515-M2	⊕ 1NO+1NC	FR 515-M2R28	⊕ 1NO+1NC
6 L	FR 613-M2	⊕ 1NO+1NC	FR 614-M2	⊕ 1NO+1NC	FR 615-M2	⊕ 1NO+1NC	FR 615-M2R28	⊕ 1NO+1NC
7 LO	FR 713-M2	⊕ 1NO+1NC	FR 714-M2	⊕ 1NO+1NC	FR 715-M2	⊕ 1NO+1NC	FR 715-M2R28	⊕ 1NO+1NC
9 L	FR 913-M2	⊕ 2NC	FR 914-M2	⊕ 2NC	FR 915-M2	⊕ 2NC	FR 915-M2R28	⊕ 2NC
10 L	FR 1013-M2	2NO	FR 1014-M2	2NO	FR 1015-M2	2NO	FR 1015-M2R28	2NO
11 R	FR 1113-M2	⊕ 2NC	FR 1114-M2	⊕ 2NC	FR 1115-M2	⊕ 2NC	FR 1115-M2R28	⊕ 2NC
12 R	FR 1213-M2	2NO	FR 1214-M2	2NO	FR 1215-M2	2NO	FR 1215-M2R28	2NO
13 LV	FR 1313-M2	⊕ 2NC	FR 1314-M2	⊕ 2NC	FR 1315-M2	⊕ 2NC	FR 1315-M2R28	⊕ 2NC
14 LS	FR 1413-M2	⊕ 2NC	FR 1414-M2	⊕ 2NC	FR 1415-M2	⊕ 2NC	FR 1415-M2R28	⊕ 2NC
15 LS	FR 1513-M2	2NO	FR 1514-M2	2NO	FR 1515-M2	2NO	FR 1515-M2R28	2NO
18 LA	FR 1813-M2	⊕ 1NO+1NC	FR 1814-M2	⊕ 1NO+1NC	FR 1815-M2	⊕ 1NO+1NC	FR 1815-M2R28	⊕ 1NO+1NC
20 L	FR 2013-M2	⊕ 1NO+2NC	FR 2014-M2	⊕ 1NO+2NC	FR 2015-M2	⊕ 1NO+2NC	FR 2015-M2R28	⊕ 1NO+2NC
21 L	FR 2113-M2	⊕ 3NC	FR 2114-M2	⊕ 3NC	FR 2115-M2	⊕ 3NC	FR 2115-M2R28	⊕ 3NC
22 L	FR 2213-M2	⊕ 2NO+1NC	FR 2214-M2	⊕ 2NO+1NC	FR 2215-M2	⊕ 2NO+1NC	FR 2215-M2R28	⊕ 2NO+1NC
E1 A	FR E113-M2	1NO-1NC	FR E114-M2	1NO-1NC	FR E115-M2	1NO-1NC	FR E115-M2R28	1NO-1NC
Max. speed	page 227 - type 2		page 227 - type 4		page 227 - type 2		page 227 - type 2	
Actuating force	8 N (25 N ⊕)		8 N (25 N ⊕)		8 N (25 N ⊕)		8 N (25 N ⊕)	
Travel diagrams	page 228 - group 1		page 228 - group 1		page 228 - group 1		page 228 - group 1	

All values in the drawings are in mm

Accessories See page 207

The 2D and 3D files are available at www.pizzato.com

FR series position switches

Contact type:

- R** = snap action
- L** = slow action
- LO** = slow action make before break
- LS** = slow action shifted
- LV** = slow action shifted and spaced
- LI** = slow action independent
- LA** = slow action close
- ⏏** = electronic PNP

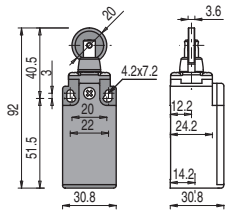

Secured only by means of threaded head in vertical position

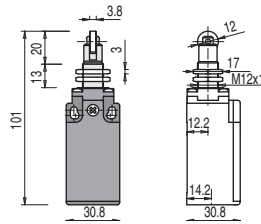

External gasket
Spring rod

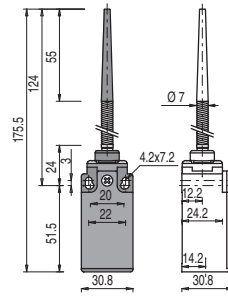

External gasket
Spring rod

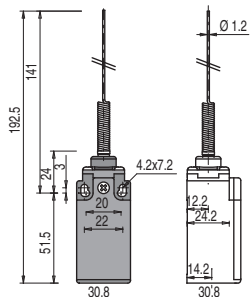

Contact block

2	R	FR 216-M2	2x(1NO-1NC)	FR 217-M2	2x(1NO-1NC)	FR 220-M2	2x(1NO-1NC)	FR 221-M2	2x(1NO-1NC)
5	R	FR 516-M2	⊕ 1NO+1NC	FR 517-M2	⊕ 1NO+1NC	FR 520-M2	1NO+1NC	FR 521-M2	1NO+1NC
6	L	FR 616-M2	⊕ 1NO+1NC	FR 617-M2	⊕ 1NO+1NC	/	/	/	/
7	LO	FR 716-M2	⊕ 1NO+1NC	FR 717-M2	⊕ 1NO+1NC	/	/	/	/
9	L	FR 916-M2	⊕ 2NC	FR 917-M2	⊕ 2NC	/	/	/	/
10	L	FR 1016-M2	2NO	FR 1017-M2	2NO	FR 1020-M2	2NO	FR 1021-M2	2NO
11	R	FR 1116-M2	⊕ 2NC	FR 1117-M2	⊕ 2NC	/	/	/	/
12	R	FR 1216-M2	2NO	FR 1217-M2	2NO	FR 1220-M2	2NO	FR 1221-M2	2NO
13	LV	FR 1316-M2	⊕ 2NC	FR 1317-M2	⊕ 2NC	/	/	/	/
14	LS	FR 1416-M2	⊕ 2NC	FR 1417-M2	⊕ 2NC	/	/	/	/
15	LS	FR 1516-M2	2NO	FR 1517-M2	2NO	/	/	/	/
18	LA	FR 1816-M2	⊕ 1NO+1NC	FR 1817-M2	⊕ 1NO+1NC	FR 1820-M2	1NO+1NC	FR 1821-M2	1NO+1NC
20	L	FR 2016-M2	⊕ 1NO+2NC	FR 2017-M2	⊕ 1NO+2NC	FR 2020-M2	1NO+2NC	FR 2021-M2	1NO+2NC
21	L	FR 2116-M2	⊕ 3NC	FR 2117-M2	⊕ 3NC	FR 2120-M2	3NC	FR 2121-M2	3NC
22	L	FR 2216-M2	⊕ 2NO+1NC	FR 2217-M2	⊕ 2NO+1NC	FR 2220-M2	2NO+1NC	FR 2221-M2	2NO+1NC
E1	⏏	FR E116-M2	1NO-1NC	FR E117-M2	1NO-1NC	FR E120-M2	1NO-1NC	FR E121-M2	1NO-1NC

Max. speed	page 227 - type 2		page 227 - type 2		1 m/s		1 m/s	
Actuating force	8 N (25 N ⊕)		8 N (25 N ⊕)		0.07 Nm		0.07 Nm	
Travel diagrams	page 228 - group 1		page 228 - group 1		page 228 - group 4		page 228 - group 4	

Contact type:

- R** = snap action
- L** = slow action
- LO** = slow action make before break
- LS** = slow action shifted
- LV** = slow action shifted and spaced
- LI** = slow action independent
- LA** = slow action close
- ⏏** = electronic PNP

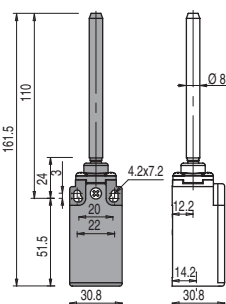

External gasket
Spring rod

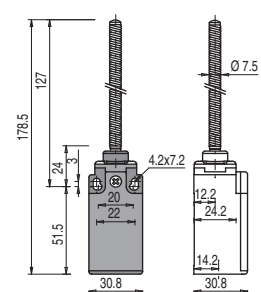

With Ø 20 mm stainless steel roller on request

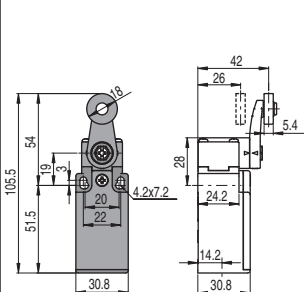

Other rollers available. See page 66

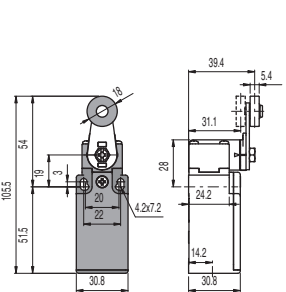

Contact block

2	R	FR 222-M2	2x(1NO-1NC)	FR 225-M2	2x(1NO-1NC)	FR 230-M2	2x(1NO-1NC)	FR 231-M2	2x(1NO-1NC)
5	R	/	/	FR 525-M2	1NO+1NC	FR 530-M2	⊕ 1NO+1NC	FR 531-M2	⊕ 1NO+1NC
6	L	/	/	/	/	FR 630-M2	⊕ 1NO+1NC	FR 631-M2	⊕ 1NO+1NC
7	LO	/	/	/	/	FR 730-M2	⊕ 1NO+1NC	FR 731-M2	⊕ 1NO+1NC
9	L	/	/	/	/	FR 930-M2	⊕ 2NC	FR 931-M2	⊕ 2NC
10	L	FR 1022-M2	2NO	FR 1025-M2	2NO	FR 1030-M2	2NO	FR 1031-M2	2NO
11	R	/	/	/	/	FR 1130-M2	⊕ 2NC	FR 1131-M2	⊕ 2NC
12	R	FR 1222-M2	2NO	FR 1225-M2	2NO	FR 1230-M2	2NO	FR 1231-M2	2NO
13	LV	/	/	/	/	FR 1330-M2	⊕ 2NC	FR 1331-M2	⊕ 2NC
14	LS	/	/	/	/	FR 1430-M2	⊕ 2NC	FR 1431-M2	⊕ 2NC
15	LS	/	/	/	/	FR 1530-M2	2NO	FR 1531-M2	2NO
16	LI	/	/	/	/	FR 1630-M2	⊕ 2NC	FR 1631-M2	⊕ 2NC
18	LA	FR 1822-M2	⊕ 1NO+1NC	FR 1825-M2	1NO+1NC	FR 1830-M2	⊕ 1NO+1NC	FR 1831-M2	⊕ 1NO+1NC
20	L	FR 2022-M2	⊕ 1NO+2NC	FR 2025-M2	1NO+2NC	FR 2030-M2	⊕ 1NO+2NC	FR 2031-M2	⊕ 1NO+2NC
21	L	FR 2122-M2	⊕ 3NC	FR 2125-M2	3NC	FR 2130-M2	⊕ 3NC	FR 2131-M2	⊕ 3NC
22	L	FR 2222-M2	⊕ 2NO+1NC	FR 2225-M2	2NO+1NC	FR 2230-M2	⊕ 2NO+1NC	FR 2231-M2	⊕ 2NO+1NC
E1	⏏	FR E122-M2	1NO-1NC	FR E125-M2	1NO-1NC	FR E130-M2	1NO-1NC	FR E131-M2	1NO-1NC

Max. speed	1 m/s		1 m/s		page 227 - type 1		page 227 - type 1	
Actuating force	0.12 Nm (0.25 Nm ⊕)		0.12 Nm		0.06 Nm (0.25 Nm ⊕)		0.06 Nm (0.25 Nm ⊕)	
Travel diagrams	page 228 - group 4		page 228 - group 4		page 228 - group 5		page 228 - group 5	

All values in the drawings are in mm

Accessories See page 207

→ The 2D and 3D files are available at www.pizzato.com

Contact type:	Square rod, 3x3 mm	Spring rod	Round rod, Ø 3 mm, stainless steel	Other rollers available. See page 66
<ul style="list-style-type: none"> R = snap action L = slow action LO = slow action make before break LS = slow action shifted LV = slow action shifted and spaced LI = slow action independent LA = slow action close Λ = electronic PNP 				
Contact block				
2	R FR 233-M2 2x(1NO-1NC)	FR 234-M2 2x(1NO-1NC)	FR 250-M2 2x(1NO-1NC)	FR 251-M2 2x(1NO-1NC)
5	R FR 533-M2 1NO+1NC	FR 534-M2 1NO+1NC	FR 550-M2 1NO+1NC	FR 551-M2 (⊕) 1NO+1NC
6	L FR 633-M2 1NO+1NC	FR 634-M2 1NO+1NC	FR 650-M2 1NO+1NC	FR 651-M2 (⊕) 1NO+1NC
7	LO FR 733-M2 1NO+1NC	FR 734-M2 1NO+1NC	FR 750-M2 1NO+1NC	FR 751-M2 (⊕) 1NO+1NC
9	L FR 933-M2 2NC	FR 934-M2 2NC	FR 950-M2 2NC	FR 951-M2 (⊕) 2NC
10	L FR 1033-M2 2NO	FR 1034-M2 2NO	FR 1050-M2 2NO	FR 1051-M2 2NO
11	R FR 1133-M2 2NC	FR 1134-M2 2NC	FR 1150-M2 2NC	FR 1151-M2 (⊕) 2NC
12	R FR 1233-M2 2NO	FR 1234-M2 2NO	FR 1250-M2 2NO	FR 1251-M2 2NO
13	LV FR 1333-M2 2NC	FR 1334-M2 2NC	FR 1350-M2 2NC	FR 1351-M2 (⊕) 2NC
14	LS FR 1433-M2 2NC	FR 1434-M2 2NC	FR 1450-M2 2NC	FR 1451-M2 (⊕) 2NC
15	LS FR 1533-M2 2NO	FR 1534-M2 2NO	FR 1550-M2 2NO	FR 1551-M2 2NO
16	LI FR 1633-M2 2NC	FR 1634-M2 2NC	FR 1650-M2 2NC	FR 1651-M2 (⊕) 2NC
18	LA FR 1833-M2 1NO+1NC	FR 1834-M2 1NO+1NC	FR 1850-M2 1NO+1NC	FR 1851-M2 (⊕) 1NO+1NC
20	L FR 2033-M2 1NO+2NC	FR 2034-M2 1NO+2NC	FR 2050-M2 1NO+2NC	FR 2051-M2 (⊕) 1NO+2NC
21	L FR 2133-M2 3NC	FR 2134-M2 3NC	FR 2150-M2 3NC	FR 2151-M2 (⊕) 3NC
22	L FR 2233-M2 2NO+1NC	FR 2234-M2 2NO+1NC	FR 2250-M2 2NO+1NC	FR 2251-M2 (⊕) 2NO+1NC
E1	Λ FR E133-M2 1NO-1NC	FR E134-M2 1NO-1NC	FR E150-M2 1NO-1NC	FR E151-M2 1NO-1NC
Max. speed	1.5 m/s	1.5 m/s	1.5 m/s	page 227 - type 1
Actuating force	0.06 Nm	0.06 Nm	0.06 Nm	0.06 Nm (0.25 Nm ⊕)
Travel diagrams	page 228 - group 5	page 228 - group 5	page 228 - group 5	page 228 - group 5

Contact type:	Other rollers available. See page 66	Porcelain roller	Other rollers available. See page 66	Other rollers available. See page 66
<ul style="list-style-type: none"> R = snap action L = slow action LO = slow action make before break LS = slow action shifted LV = slow action shifted and spaced LI = slow action independent LA = slow action close Λ = electronic PNP 				
Contact block				
2	R FR 252-M2 2x(1NO-1NC)	FR 253-E0M2 2x(1NO-1NC)	FR 254-M2 2x(1NO-1NC)	FR 255-M2 2x(1NO-1NC)
5	R FR 552-M2 (⊕) 1NO+1NC	FR 553-E0M2V9 (⊕) 1NO+1NC	FR 554-M2 (⊕) 1NO+1NC	FR 555-M2 (⊕) (1) 1NO+1NC
6	L FR 652-M2 (⊕) 1NO+1NC	FR 653-E0M2V9 (⊕) 1NO+1NC	FR 654-M2 (⊕) 1NO+1NC	FR 655-M2 (⊕) (1) 1NO+1NC
7	LO FR 752-M2 (⊕) 1NO+1NC	FR 753-E0M2V9 (⊕) 1NO+1NC	FR 754-M2 (⊕) 1NO+1NC	FR 755-M2 (⊕) (1) 1NO+1NC
9	L FR 952-M2 (⊕) 2NC	FR 953-E0M2V9 (⊕) 2NC	FR 954-M2 (⊕) 2NC	FR 955-M2 (⊕) (1) 2NC
10	L FR 1052-M2 2NO	FR 1053-E0M2V9 2NO	FR 1054-M2 2NO	FR 1055-M2 2NO
11	R FR 1152-M2 (⊕) 2NC	/	FR 1154-M2 (⊕) 2NC	FR 1155-M2 (⊕) (1) 2NC
12	R FR 1252-M2 2NO	FR 1253-E0M2V9 2NO	FR 1254-M2 2NO	FR 1255-M2 2NO
13	LV FR 1352-M2 (⊕) 2NC	FR 1353-E0M2V9 (⊕) 2NC	FR 1354-M2 (⊕) 2NC	FR 1355-M2 (⊕) (1) 2NC
14	LS FR 1452-M2 (⊕) 2NC	FR 1453-E0M2V9 (⊕) 2NC	FR 1454-M2 (⊕) 2NC	FR 1455-M2 (⊕) (1) 2NC
15	LS FR 1552-M2 2NO	FR 1553-E0M2V9 2NO	FR 1554-M2 2NO	FR 1555-M2 2NO
16	LI FR 1652-M2 (⊕) 2NC	/	FR 1654-M2 (⊕) 2NC	FR 1655-M2 (⊕) (1) 2NC
18	LA FR 1852-M2 (⊕) 1NO+1NC	FR 1853-E0M2V9 (⊕) 1NO+1NC	FR 1854-M2 (⊕) 1NO+1NC	FR 1855-M2 (⊕) (1) 1NO+1NC
20	L FR 2052-M2 (⊕) 1NO+2NC	FR 2053-E0M2V9 (⊕) 1NO+2NC	FR 2054-M2 (⊕) 1NO+2NC	FR 2055-M2 (⊕) (1) 1NO+2NC
21	L FR 2152-M2 (⊕) 3NC	FR 2153-E0M2V9 (⊕) 3NC	FR 2154-M2 (⊕) 3NC	FR 2155-M2 (⊕) (1) 3NC
22	L FR 2252-M2 (⊕) 2NO+1NC	FR 2253-E0M2V9 (⊕) 2NO+1NC	FR 2254-M2 (⊕) 2NO+1NC	FR 2255-M2 (⊕) (1) 2NO+1NC
E1	Λ FR E152-M2 1NO-1NC	FR E153-E0M2V9 1NO-1NC	FR E154-M2 1NO-1NC	FR E155-M2 1NO-1NC
Max. speed	page 227 - type 1	0.5 m/s	page 227 - type 1	page 227 - type 1
Actuating force	0.06 Nm (0.25 Nm ⊕)	0.03 Nm (0.25 Nm ⊕)	0.06 Nm (0.25 Nm ⊕)	0.06 Nm (0.25 Nm ⊕)
Travel diagrams	page 228 - group 5	page 228 - group 6	page 228 - group 5	page 228 - group 5

(1) Positive opening only with actuator set to max. See page 66.

All values in the drawings are in mm

Accessories See page 207

→ The 2D and 3D files are available at www.pizzato.com

FR series position switches

- Contact type:
- R** = snap action
 - L** = slow action
 - LO** = slow action make before break
 - LS** = slow action shifted
 - LV** = slow action shifted and spaced
 - LI** = slow action independent
 - LA** = slow action close
 - ⚡** = electronic PNP

Contact block

	Other rollers available. See page 66		Other rollers available. See page 66		Glass fibre rod		Rope switch for signalling	
2	R	FR 256-M2 2x(1NO-1NC)	R	FR 257-M2 2x(1NO-1NC)	R	FR 269-M2 2x(1NO-1NC)	R	FR 276-M2 2x(1NO-1NC)
5	R	FR 556-M2 \rightarrow 1NO+1NC	R	FR 557-M2 \rightarrow 1NO+1NC	R	FR 569-M2 1NO+1NC	R	FR 576-M2 1NO+1NC
6	L	FR 656-M2 \rightarrow 1NO+1NC	L	FR 657-M2 \rightarrow 1NO+1NC	L	FR 669-M2 1NO+1NC	L	FR 676-M2 1NO+1NC
7	LO	FR 756-M2 \rightarrow 1NO+1NC	LO	FR 757-M2 \rightarrow 1NO+1NC	LO	FR 769-M2 1NO+1NC	LO	FR 776-M2 1NO+1NC
9	L	FR 956-M2 \rightarrow 2NC	L	FR 957-M2 \rightarrow 2NC	L	FR 969-M2 2NC	L	FR 976-M2 2NO
10	L	FR 1056-M2 2NO	L	FR 1057-M2 2NO	L	FR 1069-M2 2NO	L	FR 1076-M2 2NC
11	R	FR 1156-M2 \rightarrow 2NC	R	FR 1157-M2 \rightarrow 2NC	R	FR 1169-M2 2NC	R	FR 1176-M2 2NO
12	R	FR 1256-M2 2NO	R	FR 1257-M2 2NO	R	FR 1269-M2 2NO	R	FR 1276-M2 2NC
13	LV	FR 1356-M2 \rightarrow 2NC	LV	FR 1357-M2 \rightarrow 2NC	LV	FR 1369-M2 2NC	LV	FR 1376-M2 2NO
14	LS	FR 1456-M2 \rightarrow 2NC	LS	FR 1457-M2 \rightarrow 2NC	LS	FR 1469-M2 2NC	LS	FR 1476-M2 2NO
15	LS	FR 1556-M2 2NO	LS	FR 1557-M2 2NO	LS	FR 1569-M2 2NO	LS	FR 1576-M2 2NC
16	LI	FR 1656-M2 \rightarrow 2NC	LI	FR 1657-M2 \rightarrow 2NC	LI	FR 1669-M2 2NC		/
18	LA	FR 1856-M2 \rightarrow 1NO+1NC	LA	FR 1857-M2 \rightarrow 1NO+1NC	LA	FR 1869-M2 1NO+1NC	LA	FR 1876-M2 1NO+1NC
20	L	FR 2056-M2 \rightarrow 1NO+2NC	L	FR 2057-M2 \rightarrow 1NO+2NC	L	FR 2069-M2 1NO+2NC	L	FR 2076-M2 2NO+1NC
21	L	FR 2156-M2 \rightarrow 3NC	L	FR 2157-M2 \rightarrow 3NC	L	FR 2169-M2 3NC	L	FR 2176-M2 3NO
22	L	FR 2256-M2 \rightarrow 2NO+1NC	L	FR 2257-M2 \rightarrow 2NO+1NC	L	FR 2269-M2 2NO+1NC	L	FR 2276-M2 1NO+2NC
E1	⚡	FR E156-M2 1NO-1NC	⚡	FR E157-M2 1NO-1NC	⚡	FR E169-M2 1NO-1NC		/
Max. speed	page 227 - type 1		page 227 - type 1		1.5 m/s		0.5 m/s	
Actuating force	0.06 Nm (0.25 Nm \rightarrow)		0.06 Nm (0.25 Nm \rightarrow)		0.06 Nm		initial 20 N - final 40 N	
Travel diagrams	page 228 - group 5		page 228 - group 5		page 228 - group 5		page 228 - group 7	

FR series position switches with reset



The majority of switches can be equipped with a reset device (option W3) which enables the simultaneous actuation of actuator and contact block. The device is a module that is mounted between the body and the head of the switch that can be rotated independently from the head. The reset device has the following advantages:

- can be integrated into the majority of standard actuator heads;
- contact blocks with snap action are no more necessary because the tripping movement is executed by the reset device itself;
- can be rotated independently from the head ensuring maximum flexibility during installation;
- can be delivered with two different actuating forces: standard and increased for vibration applications;
- mechanical endurance: 1 million operating cycles.

Contact type:

- R** = snap action
- L** = slow action

	With stainless steel roller on request		With stainless steel roller on request		With stainless steel roller on request	
2	R	FR 201-W3M2 2x(1NO-1NC)	R	FR 202-W3M2 2x(1NO-1NC)	R	FR 205-W3M2 2x(1NO-1NC)
6	L	FR 601-W3M2 \rightarrow 1NO+1NC	L	FR 602-W3M2 \rightarrow 1NO+1NC	L	FR 605-W3M2 \rightarrow 1NO+1NC
9	L	FR 901-W3M2 \rightarrow 2NC	L	FR 902-W3M2 \rightarrow 2NC	L	FR 905-W3M2 \rightarrow 2NC
10	L	FR 1001-W3M2 2NO	L	FR 1002-W3M2 2NO	L	FR 1005-W3M2 2NO
20	L	FR 2001-W3M2 \rightarrow 1NO+2NC	L	FR 2002-W3M2 \rightarrow 1NO+2NC	L	FR 2005-W3M2 \rightarrow 1NO+2NC
21	L	FR 2101-W3M2 \rightarrow 3NC	L	FR 2102-W3M2 \rightarrow 3NC	L	FR 2105-W3M2 \rightarrow 3NC
22	L	FR 2201-W3M2 \rightarrow 2NO+1NC	L	FR 2202-W3M2 \rightarrow 2NO+1NC	L	FR 2205-W3M2 \rightarrow 2NO+1NC
Max. speed	page 227 - type 4		page 227 - type 3		page 227 - type 3	
Actuating force	4.5 N (25 N \rightarrow)		4 N (25 N \rightarrow)		4 N (25 N \rightarrow)	
Travel diagrams	page 229 - group 1		page 229 - group 2		page 229 - group 2	

All values in the drawings are in mm

Accessories See page 207

\rightarrow The 2D and 3D files are available at www.pizzato.com

Contact type: R = snap action L = slow action	With Ø 12 mm stainless steel roller on request		With Ø 20 mm stainless steel roller on request		Other rollers available. See page 66		Other rollers available. See page 66	
Contact block								
2 R	FR 215-W3M2	2x(1NO-1NC)	FR 230-W3M2	2x(1NO-1NC)	FR 231-W3M2	2x(1NO-1NC)	FR 251-W3M2	2x(1NO-1NC)
6 L	FR 615-W3M2	1NO+1NC	FR 630-W3M2	1NO+1NC	FR 631-W3M2	1NO+1NC	FR 651-W3M2	1NO+1NC
9 L	FR 915-W3M2	2NC	FR 930-W3M2	2NC	FR 931-W3M2	2NC	FR 951-W3M2	2NC
10 L	FR 1015-W3M2	2NO	FR 1030-W3M2	2NO	FR 1031-W3M2	2NO	FR 1051-W3M2	2NO
20 L	FR 2015-W3M2	1NO+2NC	FR 2030-W3M2	1NO+2NC	FR 2031-W3M2	1NO+2NC	FR 2051-W3M2	1NO+2NC
21 L	FR 2115-W3M2	3NC	FR 2130-W3M2	3NC	FR 2131-W3M2	3NC	FR 2151-W3M2	3NC
22 L	FR 2215-W3M2	2NO+1NC	FR 2230-W3M2	2NO+1NC	FR 2231-W3M2	2NO+1NC	FR 2251-W3M2	2NO+1NC
Max. speed	page 227 - type 2		page 227 - type 1		page 227 - type 1		page 227 - type 1	
Actuating force	4.5 N (25 N \ominus)		0.07 Nm (0.25 Nm \ominus)		0.07 Nm (0.25 Nm \ominus)		0.07 Nm (0.25 Nm \ominus)	
Travel diagrams	page 229 - group 1		page 229 - group 4		page 229 - group 4		page 229 - group 4	

Contact type: R = snap action L = slow action	Other rollers available. See page 66		Other rollers available. See page 66		Other rollers available. See page 66		Other rollers available. See page 66	
Contact block								
2 R	FR 252-W3M2	2x(1NO-1NC)	FR 254-W3M2	2x(1NO-1NC)	FR 256-W3M2	2x(1NO-1NC)	FR 257-W3M2	2x(1NO-1NC)
6 L	FR 652-W3M2	1NO+1NC	FR 654-W3M2	1NO+1NC	FR 656-W3M2	1NO+1NC	FR 657-W3M2	1NO+1NC
9 L	FR 952-W3M2	2NC	FR 954-W3M2	2NC	FR 956-W3M2	2NC	FR 957-W3M2	2NC
10 L	FR 1052-W3M2	2NO	FR 1054-W3M2	2NO	FR 1056-W3M2	2NO	FR 1057-W3M2	2NO
20 L	FR 2052-W3M2	1NO+2NC	FR 2054-W3M2	1NO+2NC	FR 2056-W3M2	1NO+2NC	FR 2057-W3M2	1NO+2NC
21 L	FR 2152-W3M2	3NC	FR 2154-W3M2	3NC	FR 2156-W3M2	3NC	FR 2157-W3M2	3NC
22 L	FR 2252-W3M2	2NO+1NC	FR 2254-W3M2	2NO+1NC	FR 2256-W3M2	2NO+1NC	FR 2257-W3M2	2NO+1NC
Max. speed	page 227 - type 1		page 227 - type 1		page 227 - type 1		page 227 - type 1	
Actuating force	0.07 Nm (0.25 Nm \ominus)		0.07 Nm (0.25 Nm \ominus)		0.07 Nm (0.25 Nm \ominus)		0.07 Nm (0.25 Nm \ominus)	
Travel diagrams	page 229 - group 4		page 229 - group 4		page 229 - group 4		page 229 - group 4	

Increased actuating force



The switch can be delivered with increased actuating force (option W4). Ideal for vibration applications.

Actuators	Actuating force
01, 14, 15, 16	7 N
02, 05	6 N
07	3.5 N
30 ... 57	0.08 Nm

To order the switch with reset and increased actuating force, replace the -W3 option with -W4 in the order code.

Example: FR 601-W3M2 → FR 601-W4M2

Position switches with swivelling lever without actuator

- Contact type:
- R** = snap action
 - L** = slow action
 - LO** = slow action make before break
 - LS** = slow action shifted
 - LV** = slow action shifted and spaced
 - LI** = slow action independent
 - LA** = slow action close
 - A** = electronic PNP
- Contact block

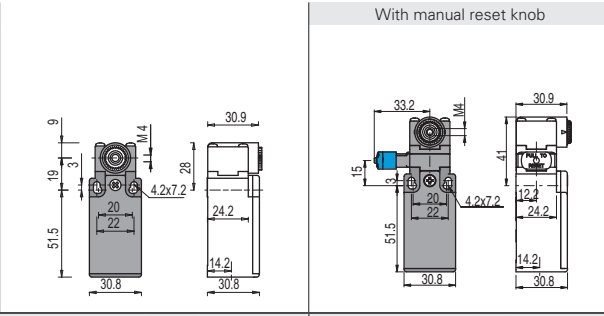

IMPORTANT
For safety applications: join only switches and actuators marked with symbol ⊕ next to the product code.
 For more information about safety applications see details on page 223.

2	R	FR 238-M2	2x(1NO-1NC)	FR 238-W3M2	2x(1NO-1NC)
5	R	FR 538-M2	⊕ 1NO+1NC	/	/
6	L	FR 638-M2	⊕ 1NO+1NC	FR 638-W3M2	⊕ 1NO+1NC
7	LO	FR 738-M2	⊕ 1NO+1NC	/	/
9	L	FR 938-M2	⊕ 2NC	FR 938-W3M2	⊕ 2NC
10	L	FR 1038-M2	2NO	FR 1038-W3M2	2NO
11	R	FR 1138-M2	⊕ 2NC	/	/
12	R	FR 1238-M2	2NO	/	/
13	LV	FR 1338-M2	⊕ 2NC	/	/
14	LS	FR 1438-M2	⊕ 2NC	/	/
15	LS	FR 1538-M2	2NO	/	/
16	LI	FR 1638-M2	⊕ 2NC	/	/
18	LA	FR 1838-M2	⊕ 1NO+1NC	/	/
20	L	FR 2038-M2	⊕ 1NO+2NC	FR 2038-W3M2	⊕ 1NO+2NC
21	L	FR 2138-M2	⊕ 3NC	FR 2138-W3M2	⊕ 3NC
22	L	FR 2238-M2	⊕ 2NO+1NC	FR 2238-W3M2	⊕ 2NO+1NC
E1	A	FR E138-M2	1NO-1NC	/	/
Actuating force		0.06 Nm (0.25 Nm ⊕)		0.07 Nm (0.25 Nm ⊕)	
Travel diagrams		page 228 - group 5		page 229 - group 4	

Separate actuators

IMPORTANT: These separate actuators can be used only with items of the FR, FM, FX, FZ and FK series.

Technopolymer roller Ø 18 mm	Technopolymer roller Ø 18 mm	Adjustable square rod, 3x3x125 mm	Spring rod with plastic tip	Adjustable round rod Ø 3x125 mm	Technopolymer roller Ø 20 mm	
VF LE30 ⊕	VF LE31 ⊕	VF LE33	VF LE34	VF LE50	VF LE51 ⊕	
Technopolymer roller Ø 20 mm	Porcelain roller	Technopolymer roller Ø 20 mm	Adjustable actuator with technopolymer roller	Adjustable safety actuator with technopolymer roller	Technopolymer roller Ø 20 mm	Adjustable glass fibre rod
VF LE52 ⊕	VF LE53 ⊕ (2)	VF LE54 ⊕	VF LE55 ⊕ (1)	VF LE56 ⊕	VF LE57 ⊕	VF LE69

All values in the drawings are in mm

Accessories See page 207

→ The 2D and 3D files are available at www.pizzato.com

Special separate actuators

IMPORTANT: These separate actuators can be used only with items of the FR, FM, FX, FZ and FK series.

Stainless steel rollers, Ø 20 mm

VF LE31-R24 (4)	VF LE51-R24 (4)	VF LE52-R24 (4)	VF LE54-R24 (4)	VF LE55-R24 (1)	VF LE56-R24 (4)	VF LE57-R24 (4)

Technopolymer rollers, Ø 35 mm

VF LE31-R25 (4)	VF LE51-R25 (4)	VF LE52-R25 (4)	VF LE54-R25 (4)	VF LE55-R25 (1)	VF LE56-R25 (4)	VF LE57-R25 (4)

Rubber rollers, Ø 40 mm

VF LE31-R5 (4)	VF LE51-R5 (4)	VF LE52-R5 (4)	VF LE54-R5 (4)	VF LE55-R5 (1)	VF LE56-R5 (4)	VF LE57-R5 (4)

Rubber rollers, Ø 50 mm

VF LE51-R26 (4)	VF LE52-R26 (4)	VF LE54-R26 (4)	VF LE55-R26 (1)	VF LE56-R26 (4)	VF LE57-R26 (4)

Protruding rubber rollers, Ø 50 mm

VF LE55-R27 (1)	VF LE56-R27 (4)

- (1) Actuator VF LE55 can only be used in safety applications if adjusted to its max. length, as shown in the figure to the right. If an adjustable lever is required for safety applications, use the VF LE56 adjustable safety lever.
- (2) The position switch obtained by assembling switch FR •38-M2 (e.g. FR 538-M2, FR 638-M2, ...) with actuator VF L53 will not present the same travel diagrams and actuating forces as switch FR •53-E0M2V9 (e.g. FR 553-E0M2V9, FR 653-E0M2V9, ...).
- (4) The actuator cannot be rotated to the inside because it will hit the switch head upon actuation.

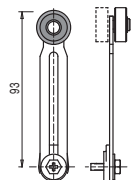

All values in the drawings are in mm

Accessories See page 207

→ The 2D and 3D files are available at www.pizzato.com